

# Lindapter®

## Innovative steel connection solutions for Fabricators

When compared to more traditional methods such as welding or drilling and bolting, Lindapter's unique solution to connecting steelwork saves time, both on and off site, reducing associated risks and overall project costs. The installation process allows for adjustability, reducing the need for expensive and timely surveys and can be installed using standard hand tools without causing any damage to the steelwork and finishes.

### Key Benefits



**Save time and money**



**Safer connections**



**Adjustable on-site**



**Fast, precise detailing**

UP TO  
**50%  
FASTER**  
than site welding

UP TO  
**28%  
FASTER**  
than drilling  
and bolting

UP TO  
**35%  
COST  
SAVING**  
compared with  
site drilling



[www.Lindapter.com](http://www.Lindapter.com)



[support@Lindapter.com](mailto:support@Lindapter.com)



+44 (0) 1274 521444

# Helping you overcome challenges in steel construction

Lindapter's expertise and independently accredited solutions can help Fabricators at every stage of the construction process. Read just some of the ways that we can help you below...



## Stage 1: Pre-Construction

Lindapter offers **FREE** technical assistance in-person or online. Our unique connection solutions improve the overall efficiency of your project by reducing risk and delays on-site, helping you save time and money.



## Stage 2: Tender

Lindapter's adjustable solutions eliminate the need for costly detailed surveys and can lower your project costs. We also provide assistance with Pre-Qualification Questionnaires (PQQs), so you can focus on other important aspects of the project.



## Stage 3: Design & Detailing

Lindapter can detail a **FREE** bespoke connection based on your specific requirements. Our Technical Support Engineers supply **FREE** customised 2D CAD drawings and 3D BIM compatible files to complement your designs.



## Stage 4: Fabrication

Lindapter products are known for their adjustability and versatility, resulting in efficient and cost-effective solutions. Therefore, our products remove any alignment issues and delays on site, ensuring seamless workflow in the workshop.



## Stage 5: On-site Installation

Challenges can occur on-site when connecting steel using traditional methods. Lindapter's Engineers offer on-site visits to provide specialised advice and solutions which minimise project delays and associated risks.

# Unrivalled technical support service

We offer comprehensive design and support, tailoring our products to your application. Our team of qualified Structural and Mechanical Engineers are on hand to work with you to deliver the highest level of service from initial concept designs through to completion.



## Pre-Construction: How we can help...

Visit [www.Lindapter.com](http://www.Lindapter.com) to book a **FREE** Technical Presentation or contact our experienced Technical Support team at [support@Lindapter.com](mailto:support@Lindapter.com) to discuss your connection requirements.

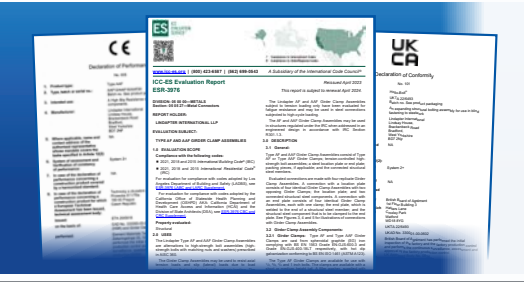

## Tender: How we can help...

Our experienced engineers can work with you on your next tender to design the perfect connection detail. They will recommend the correct product for your specific requirement and assist with route to supply for costs.

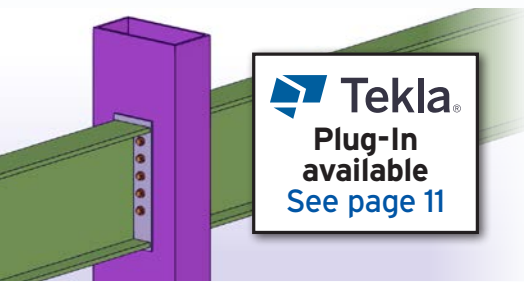

## Design & Detailing: How we can help...

Send your requirements to [support@Lindapter.com](mailto:support@Lindapter.com) or visit [www.Lindapter.com](http://www.Lindapter.com) and take advantage of our **FREE** online design tools. Alternatively, download the CAD and BIM files directly from our website.



## Fabrication: How we can help...

Our efficient solutions speed up the fabrication process and ensure the continuation of work through the workshop. For support, reach out to our team of expert engineers.



## On-site Installation: How we can help...

Your local Lindapter Sales Engineer can offer toolbox talks to provide installation guidance and advice on best practice. To arrange a site visit go to [www.Lindapter.com/contact](http://www.Lindapter.com/contact) and fill in the enquiry form or call 01274 521444.

# Lindapter Product Focus: Girder Clamps

Lindapter clamping systems provide a fast, cost-effective alternative to on-site drilling or welding by helping to reduce installation time and labour costs. High strength, permanent (or temporary) connections are achieved by simply clamping two steel sections together.

## Typical Configurations

**Girder Clamps are highly versatile products that can be used with virtually any shape or size of steel section.**

Depending on the application, the clamp is configured to suit the required loading condition (see examples right). Lindapter can design and manufacture entire assemblies for specific applications.

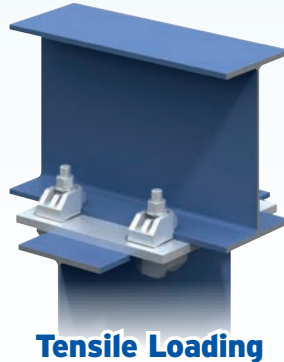

**Tensile Loading**



**Slip Resistance**



**Combined Loads**

## Install in three easy steps

**1) Bring the location plate and the lower beam into position below the upper beam.**

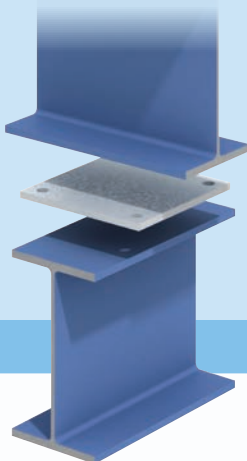

**2) Fit the bolts with two Lindapter clamps, any packings required, a nut and a washer.**



**3) Using a torque wrench, simply tighten each bolt to the recommended torque.**

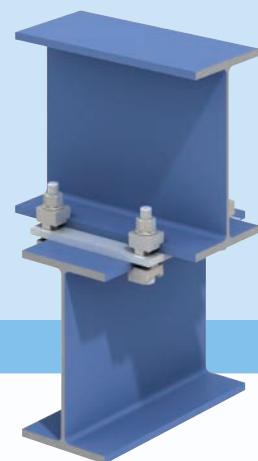

## Proven connection solutions

### Whitemoor Power Station, UK

**Product:** Type AF & Type A Girder Clamps  
**Application:** Weld free, safe and adjustable solution for connecting steel sections together to create pipe support structures.

Lindapter designed several simple but safe connections using a variety of adjustable girder clamps that eliminated the need for on-site drilling in this hazardous environment. The fabricator avoided the need for complex setting out, drilling, or welding in the workshop, removing any possible alignment issues on-site.



# Girder Clamps vs Traditional Connection Methods

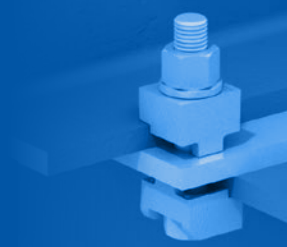

## Conventional Welding / Drilling

VS

## Lindapter Girder Clamps

✘ No adjustability without additional work, e.g site welding and on site hot works.

✔ No welding or drilling on-site is needed, and adjustments can be made for accurate alignment.

✘ Damage to steelwork and coatings resulting in expensive and time consuming touching up on site.

✔ Applied directly to finished steelwork with no damage to corrosion protection.

✘ Time consuming.

✔ Fast installation and lower labour costs.

✘ Accessible power supply required.

✔ Power is not required so all areas are accessible.

✘ Requires expensive skilled workforce and specialist equipment.

✔ Installation requires hand tools only, reducing labour and equipment costs.

✘ Hot works can result in large shutdown to reduce risk.

✔ No hot work required, minimises fire risk and required only minimal local shutdown.

✘ Remedial work due to onsite alignment issues can have an adverse effect on the project programme and cost.

✔ Complete onsite adjustability avoids remedial work, delays and increased costs.

✘ If design information is unavailable or late during fabrication it can result in expensive delays and/or costly site works or delays both in the workshop and on site.

✔ Lindapter solutions allow fabrication to continue with minimal project delays, providing an easy, cold fix, on site connection solution.



# Lindapter Product Focus: Hollo-Bolt®

The original expansion bolt for structural steel quickly connects steel sections to pre-drilled Structural Hollow Section (SHS), requiring access from one side only, providing a faster alternative to welding or through-bolting, reducing construction time and labour costs.

## Head Variants

The **Hexagonal Head** shows the bolt head above the steel section's surface.

The **Countersunk (Bolt) Head** includes a special collar that accommodates the entire head so that drilling countersunk holes is not necessary.

The innovative **Flush Fit** Hollo-Bolt is entirely concealed within the countersunk hole once installed, giving a clean and aesthetically pleasing finish.



**Hexagonal Head**



**Countersunk Head**



**Flush Fit Head**

## Install in three easy steps

1) Align the pre-drilled fixture and insert the Hollo-Bolt.

2) Grip the Hollo-Bolt collar with an open ended spanner.

3) Using a torque wrench, simply tighten the central bolt to the recommended torque.

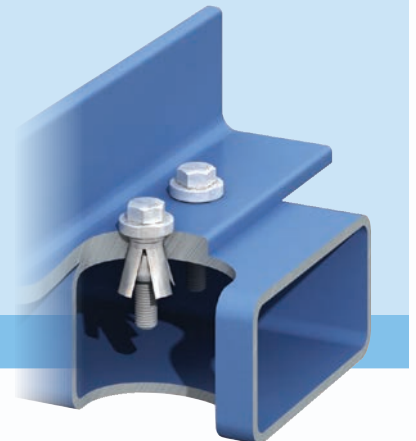
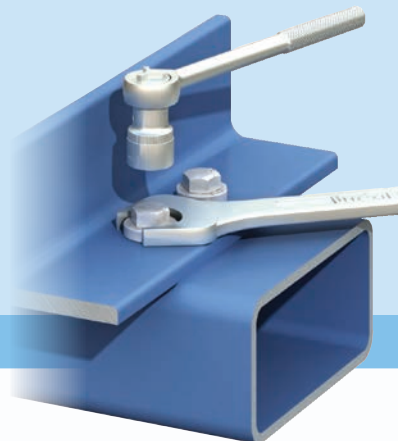

## Proven connection solutions

### Solar Car Charging Stations, Germany

**Product:** Hollo-Bolt by Lindapter

**Application:** Simple solution for connecting the Structural Hollow Sections (SHS) of solar roof frames together on-site without welding.

Lindapter designed several splice connections using Hollo-Bolt, the original expansion bolt for structural steel that requires access to only one side of the SHS. The fabricator was able to manufacture the structural hollow sections off-site before delivering them to site where they were assembled without welding.



# Hollo-Bolt® vs Traditional Connection Methods



## Conventional Connection Methods

VS

## Lindapter Hollo-Bolt®

✘ Through bolting hole alignment issues on site are expensive and could delay installation. Through bolting can also have a negative effect on the architectural benefits of using hollow sections and potentially run the risk of deforming the section.

✔ One side only installation, maintaining the SHS integrity and architectural benefits.

✘ Expensive non-destructive testing is needed when welding hollow sections together.

✔ No site welding and NDT Tests required, reducing potential project delays.

✘ Through-bolting can be inappropriate for larger Structural Hollow Section and strength of connection is not guaranteed.

✔ A reliable high strength fixing, supported by independently approved Safe Working Loads.

✘ Brackets and strapping is time-consuming, can damage the section and provide an unsightly finish.

✔ Architectural options include the Hollo-Bolt Flush Fit for a very discreet connection.

✘ Strength of the connection is not guaranteed.

✔ High shear and tension resistance.

✘ If design information is unavailable or late it can result in additional project costs.

✔ We can provide a solution to an unforeseen problem during fabrication.



# Lindapter Product Focus: Floor Fixings

A range of innovative fixings for securing steel flooring to the supporting steelwork without the need for on-site drilling or welding. Access to the underside of the flooring is not required, eliminating the need for costly scaffolding or elevated floors.

## Product Range

**Type FF - FloorFast™** secures chequer plate flooring to supporting steelwork. The stepped clamping face locks under the steelwork to provide a secure connection.

**Type GF - Grate-Fast™** is a high strength fixing for rectangular open bar grating, providing superior clamping force due to a malleable iron cast body.

**Type 1055** is a unique solution enables solid plate flooring to be fitted to open-mesh or open-grid flooring using simple hand tools.



**Type FF  
FloorFast™**

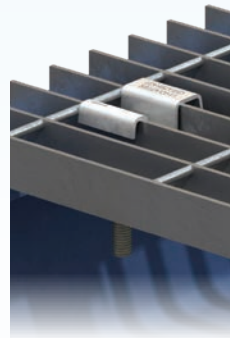

**Type GF  
Grate-Fast™**

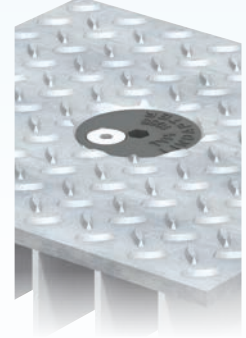

**Type  
1055**

## Install in five easy steps

- 1) Assemble bolt and FloorFast™ through the chequer plate.
- 2) Align castings with the straight edge parallel to the edge of the plate and hand tighten.
- 3) Lay the floorplate into position.
- 4) Using a hexagon key release countersunk screw one full turn.
- 5) Tighten down the countersunk socket screw.

**Removal**  
Using a hexagon key, give the FloorFast™ one full anti-clockwise turn to release the connection from the flange.

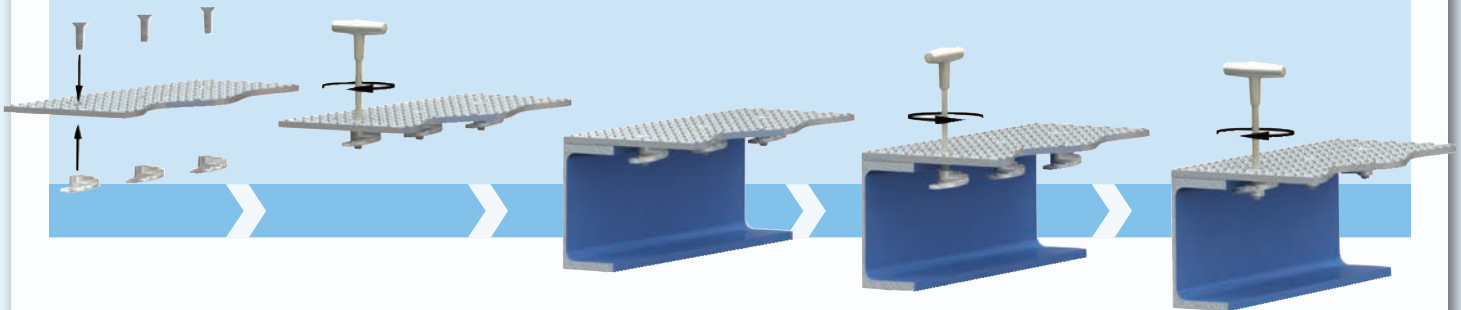

## Proven connection solutions

### Arnside Viaduct, UK

**Product:** Type FF - FloorFast

**Application:** Fast installation of maintenance walkways during the renovation of the viaduct without drilling, welding or scaffolding on-site.

Lindapter FloorFast were specified to quickly secure chequer plate flooring to the steel box sections of a new deck. The fabricator manufactured sections of the new deck in the workshop and saved time by using FloorFast instead of welding. The new deck sections were then delivered to site and lowered into position.





# Floor Fixings vs Traditional Connection Methods

## Conventional Connection Methods

VS

## Lindapter Floor Fixings

✘ Access to both the underside and top side of the flooring during installation increases working at height, requiring additional labour.

✔ FloorFast fixings can be pre-installed to the floor panels at ground level or off site, reducing any working at height with minimal labour required.

✘ Requires power tools or welding consumables.

✔ Easy to install reducing both labour and equipment costs.

✘ Traditional fixing methods result in alignment issues on site and expensive remedial work.

✔ Lindapter floor fixings are adjustable and clamp to the underside of the supporting steelwork, removing any alignment risks.

✘ Need for costly scaffolding on elevated floors which can hinder other trades.

✔ Access to the underside of the flooring is not required. Panels can be easily removed for maintenance purposes.

✘ Requires expensive skilled workforce and specialist equipment.

✔ No requirement for on-site drilling or welding encouraging safer construction.

✘ Hot work results in area closure.

✔ Removes the need for hot work permits.

✘ Susceptible to both shock and vibration leading to an inferior clamping force.

✔ High strength, resistant to both shock and vibration providing a superior clamping force over the life of the connection.



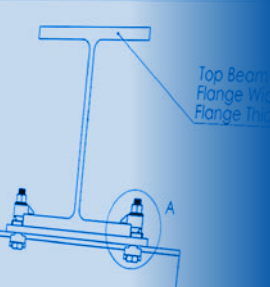

# Free Connection Detailing

Lindapter can design a bespoke connection based on your specific requirements for FREE! Our Technical Support team will supply customised CAD drawings and BIM compatible files to complement your structural designs.

## How to receive your FREE bespoke connection

1) Email your connection requirement to support@Lindapter.com

2) Lindapter's experienced Engineers will design your bespoke solution

3) An Engineer will send you a detailed connection drawing (see below)

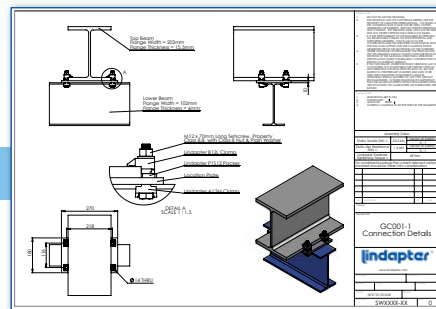
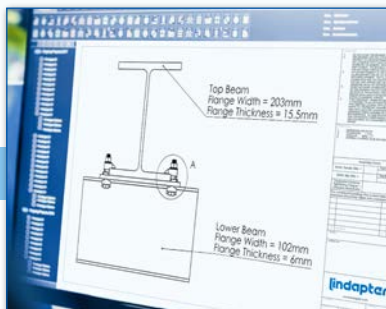
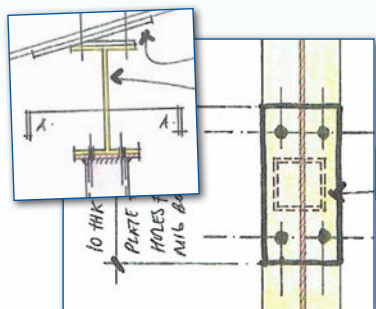

## What we require...

If you would like Lindapter to design your custom connection, please make sure to have the following:

1. Steel sizes to be used or flange width and thickness
2. Loads to be resisted (eg. 10kN tension and 15kN slip)
3. General arrangement sketch / verbal description
4. Project Name / Title / Location (optional)

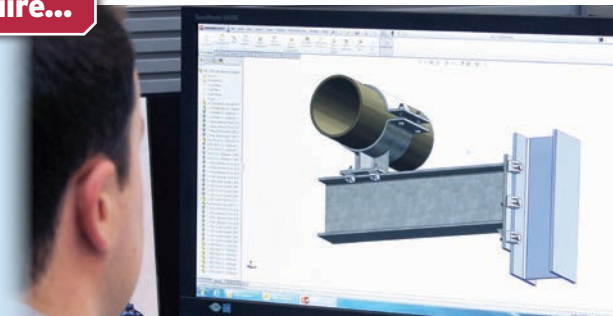

The Design Sheet includes the following:

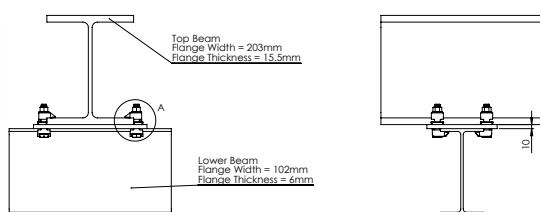

Lindapter product requirements

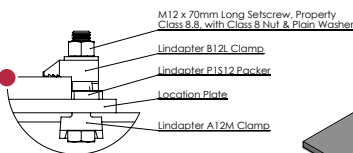

Additional dimensions for precise fabrication

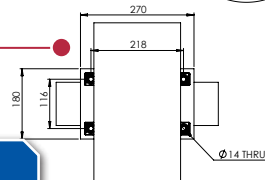

Your company name

Assembly Data (allowable loads, torque requirements and Factor of Safety used)

DO NOT SCALE THIS DRAWING. DIMENSIONS AND THE CONNECTION THEREIN ARE THE PROPERTY OF LINDAPTER. THE USER SHALL BE RESPONSIBLE FOR THE CONNECTION THAT IS MADE FROM THIS DETAIL. CONSULT THE COMPANY THAT IS MADE FROM THIS DETAIL FOR ANY OTHER RELEVANT INFORMATION. IT IS THE RESPONSIBILITY OF THE USER TO VERIFY THE CONNECTION IS MADE FROM THIS DETAIL. THE USER SHALL BE RESPONSIBLE FOR THE CONNECTION THAT IS MADE FROM THIS DETAIL. THE USER SHALL BE RESPONSIBLE FOR THE CONNECTION THAT IS MADE FROM THIS DETAIL.

Assembly Data	
Static Tensile SWL	23.2 kN
Static Slip Resistance SWL	1.4 kN
Lindapter Tightening Torque	49 Nm

For combined loading the current relevant national standard should be taken into consideration.

Bespoke project name or detail

GC001-1  
Connection Details  
lindapter

Lindapter distributor purchasing information

www.lindapter.com

NOT TO SCALE  
SWXXXX-XX

## Additional technical support services available to you

We offer comprehensive design and support, tailoring our products to your application. Our team of qualified Structural and Mechanical Engineers will work with you to deliver the highest level of service from initial concept designs through to completion.

### Engineered Solutions

Lindapter's Research & Development facility and unique expertise facilitates a bespoke product development service, passionately referred to as 'Engineered Solutions'.

Supported by the latest technology including 3D modelling, rapid prototyping with the aid of two in-house 1,000kN hydraulic test machines and finite element analysis, Lindapter's Engineers can develop solutions that satisfy your connection demands.

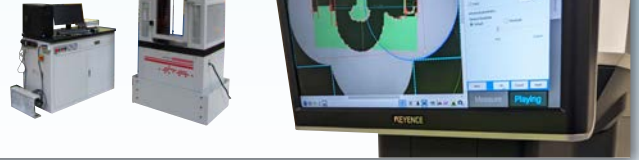

### Technical Presentations

We offer Technical Presentations either in person or online and run regular live webinars.

To learn more about the unique solutions offered by Lindapter, simply complete the form on our website at [www.Lindapter.com/cpd-technical-presentation](http://www.Lindapter.com/cpd-technical-presentation). Once we receive your request we will contact you to confirm the date and time.

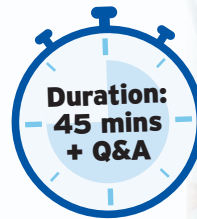

### Available in Tekla Warehouse: Hollo-Bolt Plug-In Tool

Facilitating the efficient and accurate detailing of the Hollo-Bolt system into structural steel models, this time-saving tool enables Lindapter Hollo-Bolts to be incorporated directly into a Tekla user's 3D BIM model.

Rather than detailing a bolt connection in isolation, the tool creates a parametric component preventing users from going outside of the set parameters, in turn contributing to a more seamless installation and assembly stage on site with minimal rework required.



### Sustainable Solutions

Lindapter's commitment to sustainability offers a distinct advantage for fabricators seeking eco-friendly solutions. Our products are designed to minimise waste and reduce environmental impact, while ensuring high performance and durability. We prioritise the use of recyclable materials and work closely with suppliers to ensure responsible sourcing.

By choosing Lindapter, fabricators can align with sustainable practices and contribute to a greener future while enjoying the efficiency, versatility, and cost-effectiveness of Lindapter solutions in their fabrication processes.



[www.Lindapter.com](http://www.Lindapter.com)



[support@Lindapter.com](mailto:support@Lindapter.com)



+44 (0) 1274 521444

**lindapter**<sup>®</sup>



# Independently approved accreditations to support your PQQ

For over 85 years, Lindapter has manufactured to the highest standards, earning a multitude of independent approvals and a reputation synonymous with safety and reliability.

## Current accreditations include:



These approvals reinforce Lindapter's extensive testing procedures. Products are tested so that Fabricators, Engineers and Contractors can be confident they will perform as expected. For assistance with your next PQQ, download the approval certificates from [www.Lindapter.com](http://www.Lindapter.com) or contact your local Sales Engineer.